

Wilga 100 & 50cc

Assembly Manual



Caution!

You should not regard this plane as a toy!













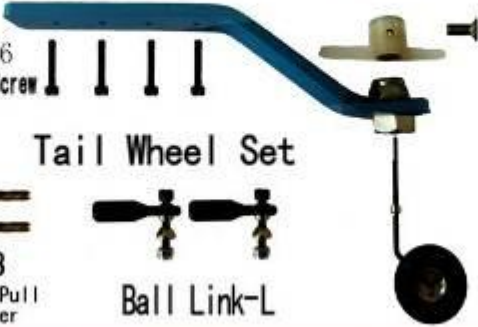



















To ensure safety, please read this instruction manual thoroughly before assembly.

Building and operating a model plane requires diligent practice and correct guidance. An inexperienced flyer can cause serious injury and property damage.

Seek the assistance of an experienced RC pilot or model airplane club for help with assembly, operation and maintenance to ensure your flying experience is both enjoyable and safe.

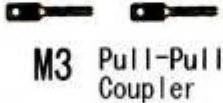
Fly only in AMA (Academy of Model Aeronautics) approved areas. Approved areas or areas approved by the Model Association of your country.

Note: the accessories coming with airplane may not same as below list. Please inquire it with the distributor.

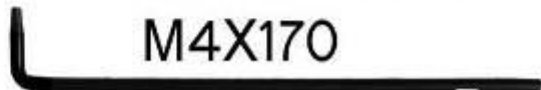
| | | |
|---|--|---|
| <p>Fuselage parts</p> <p>Rudder Horn</p>  | <p>M5x3 14</p>  <p>M3X16 Socket Screw</p>  <p>Tail Wheel Set</p>  <p>M3 Pull-Pull Coupler</p>  <p>Ball Link-L</p>  <p>Hook & Loop Fastening Tape</p>  <p>1000CC Fuel Tank</p>  <p>2mm Linkage Stop 1</p>  <p>2X200mm Throttle PushRod</p>  | <p>Cowling Canopy</p> <p>M4 Washer</p>  <p>M4X25 Socket Screw</p>  <p>M3X33 Self Tapping Screw</p>  <p>Landing Gear</p> <p>M4X16 4 Socket Screw</p>  <p>M4 Washer</p>  <p>M4 Lock nut</p>  <p>M4X12 TP Screw</p>  <p>Pu Wheel 5"</p>  |
| <p>Main Wing parts</p> <p>M6X50 Nylon Screw</p>  <p>Carbon Wing Tube 30X32X1300</p>  | <p>Ball Link-L</p>  <p>3X65mm Push Rod</p>  <p>Control Linkage</p>  | |
| <p>Elevator parts</p> <p>M3X15 Self Tapping Screw</p>  <p>Carbon Stab Tube 13X15X400 mm</p>  | <p>Ball Link-S</p>  <p>3X45 mm Push Rod</p>  <p>Control Linkage</p>  | |
| <p>Rudder parts</p> <p>Dia. 0.6mm Wire 1300mmx2</p>  | <p>M3 Pull-Pull Coupler</p>  <p>M5X25 Socket Screw</p>  <p>Cable Copper Fixer 8</p>  <p>Ø2mm</p>  <p>Ball Link-S</p>  <p>M4X170</p>  | |



Scale aluminum spinner



Main Landing Gear Installation

Gather the main landing gear, gear cover, and the wheels



Take off the braces and insert the landing gear into the gear cover

Note: Most airplane do Not have these brace. We donot attach these braces, because it is only for scale, no other use.

Fix on the wheels



Install the landing gear into the fuselage by screws as shown.

Stick the gear cover onto the fuselage by tapes.

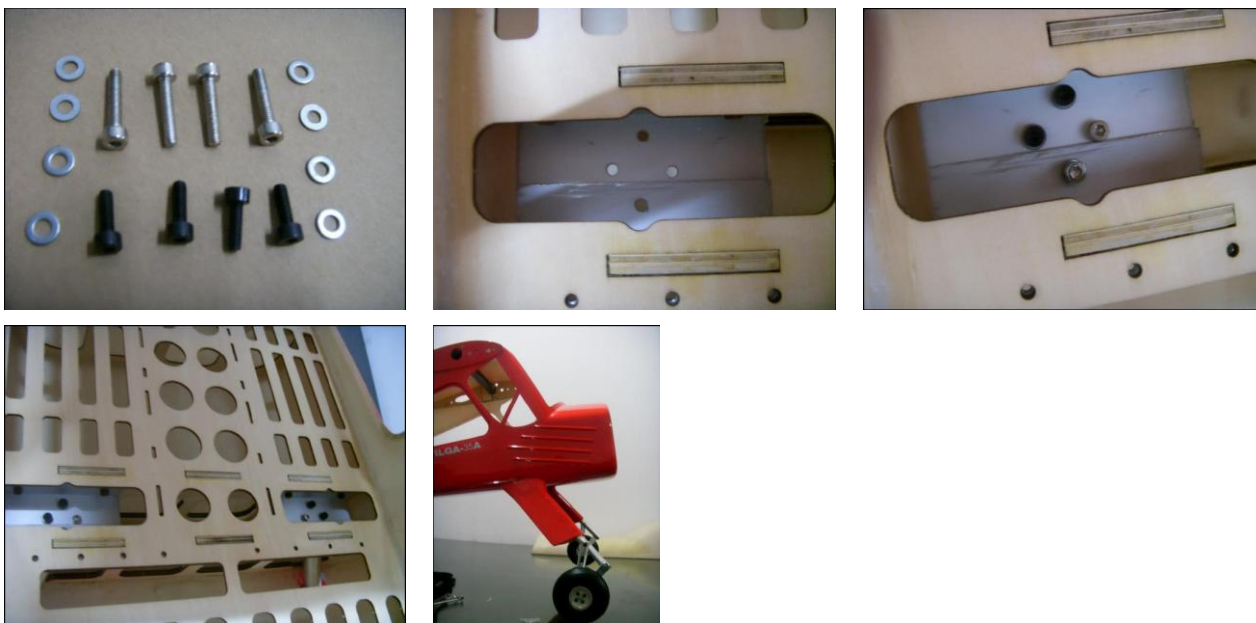

The distance to the upper screw (gear cover screw) is 130mm.

The distance of the two screws is 14mm.

This is the information for your to drill the holes (3mm) for the gear cover screws. And also the information for the gear braces hole that you need to drill on the gear cover.

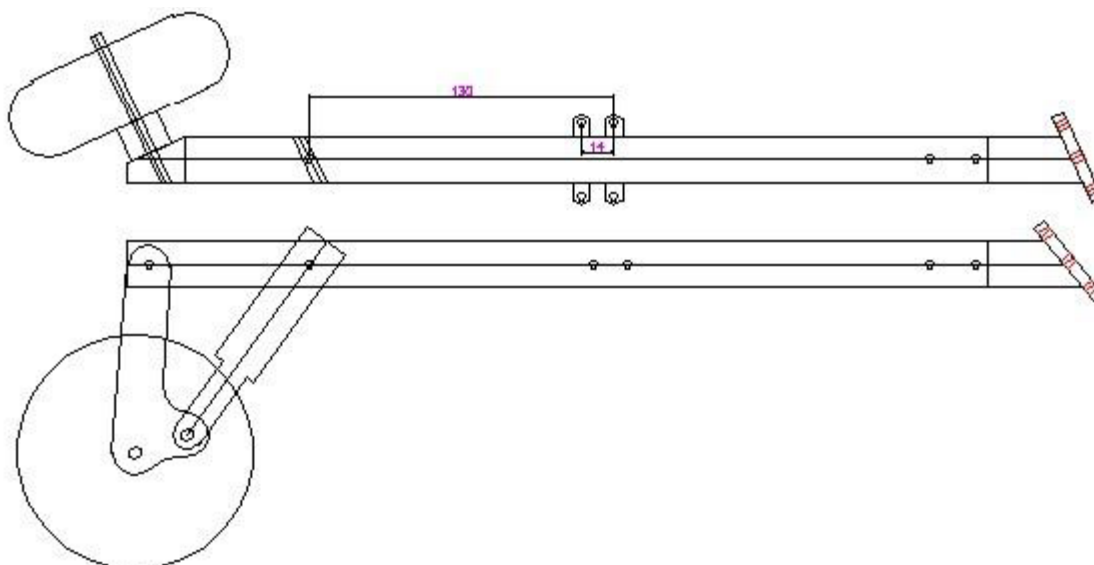

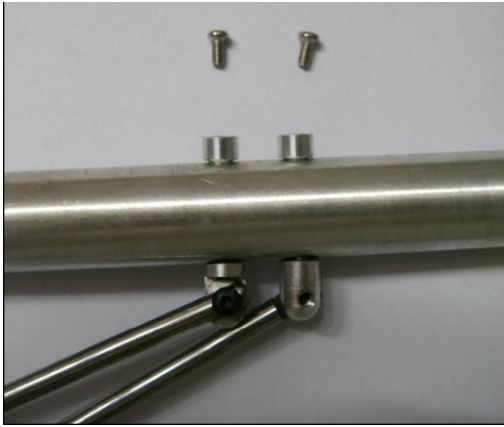

Use 3mm taps to lock the landing gear cover

Drill another two holes on the fuselage for the gear braces.

The gear braces is for scale look. So you just need to insert the gear braces into the fuselage

LED light

Find out the LED light system.

Insert the LED light into the holder as shown.

Find out the holes for the LED light in the wings and rudder.

The voltage for the light is 6V.

Find out the hole for the LED light on the top of the rudder and cut it out.

Insert the LED light wire from the top of rudder, and glue it onto the rudder.

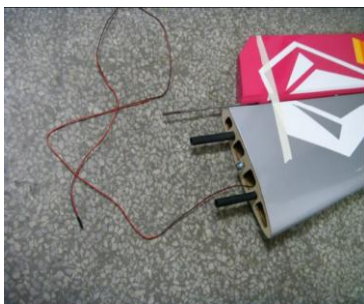
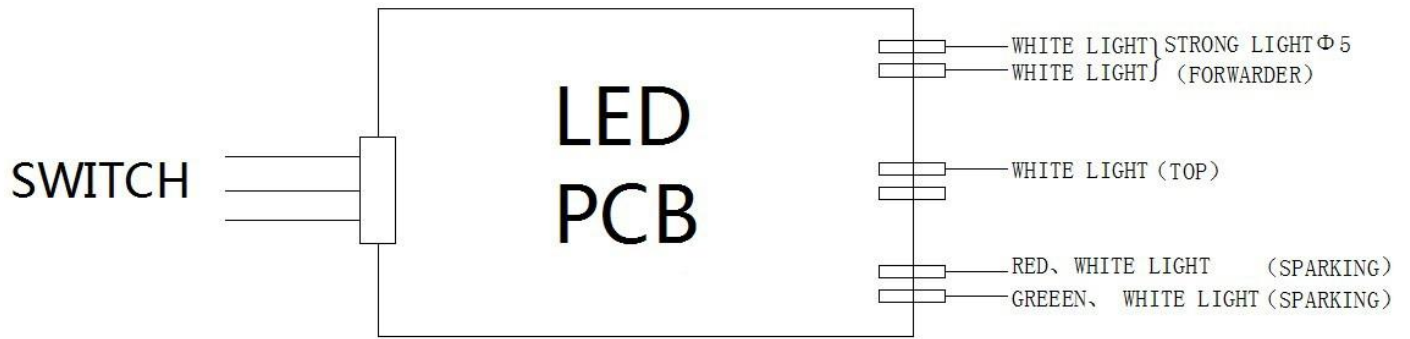

Rudder and tail wheel Installation

Find out the steel as shown, insert it into the rudder and glue it.

Connect the rudder onto the fuselage by two pcs of carbon fiber tubes.

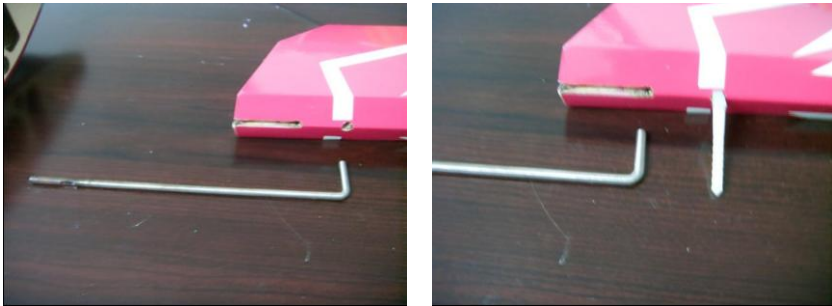

Connect it as shown, totally four pcs of wires.

Always do the wire insert the metal tube twice and scrimp the tube.

Insert the steel into the arm, and use screw to lock the steel with the arms.



Findout the parts bag for the tail landing gear

Assembly it as shown

Install the tail landing gear into the fuselage tail with screws

Connect one side of the wire with the rudder and tail servo in the fuselage.

And another side to the arm to steel the tail wheel as shown.

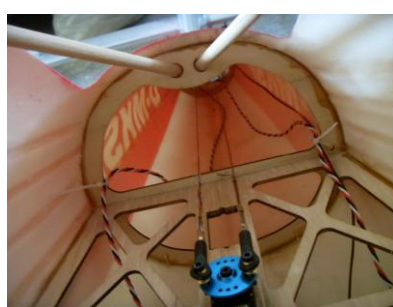
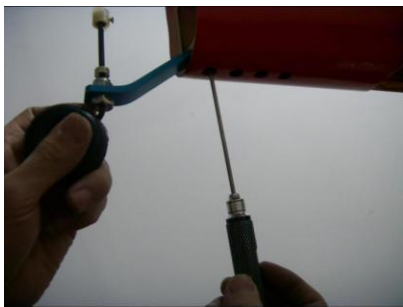

Stabs and Elevator Installation

Servo for elevator is hidden way to install.

Install the control horn on the elevators, connect the servo to the control horn by push rod and ball-links.

There are many holes on the stabs to make you easy to take off and lock the stabs with many times.

Cut out the holes to lock the stabs.

Mark the hole position on the fuselage, then drill holes on the fuselage.

Use self-taps to install the stabs onto the fuselage.



Main Wing Assembly



Parts for Main wing installation

- 1 Remove the covering from the servo position. Find out the slot pre-opened for rudder control horn, remove the film. as shown.
- 2 Fit the control horn into the slot, glue the horns into the aileron of each side.
- 3 Drill holes for the servo mounting screws and harden the wood around

the holes with a drop of thin CA.

4 Use the safety clips (buy separately) to secure the servo and servo extension connected.

5 Put the servo into the servo hole, and mark the position for the screw to fixup the servo. Pull the extension lead through to the root of the wing.



6 Drill holes for the servo mounting screws and harden the wood around the holes with a drop of thin CA.

7 Install the control horn. Adjust the horn and servo arm. Fix the horn in place firmly. Install the ball link and push rod . Make sure it's firm and flexible.

8 Repeat the previous steps for the other wing. Please install the wing tube and wing bolts in the final assembly.



Engine Installation

Pre-marked holes for the engine

1 there marks also how much you need to add to make the right thrust and down thrust.

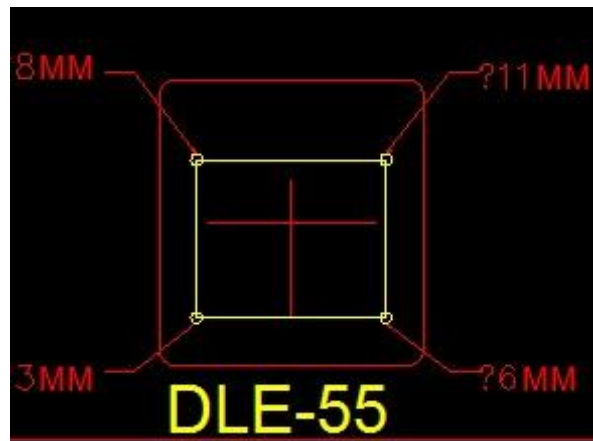
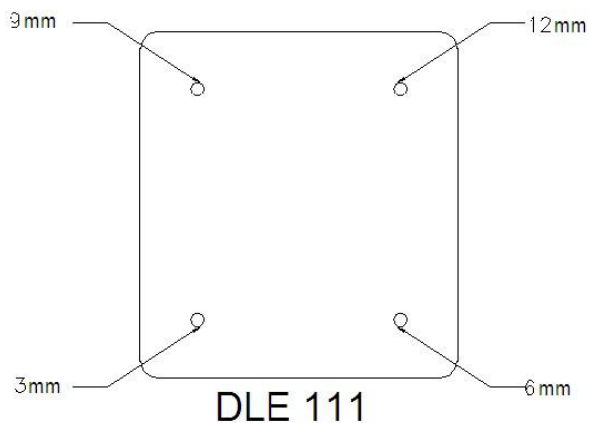

- 2 Insert the bolts through flat fender washers, the firewall and into the engine stand offs. Tighten firmly. Secure mounting bolts nuts with Blue Loctite.
- 3 Use a bit to drill a pushrod exit hole on the firewall in line with the engine carburetor throttle arm.
- 4 Attach the ball link to the throttle pushrod and secure to the carburetor throttle arm with a bolt and nylon lock nut.
- 5 Insert the throttle servo into the servo mounting tray with an output arm

forward. Insert the throttle pushrod into the servo arm easy link.

6 Mark a line for the throttle servo tray, then glue it to the fuselage.

7 Use a drill to drill the servo mounting holes. Install the servo with servo screws.



8 Insert the throttle pushrod into the servo easy link. Move the servo arm to the center position. So that carburetor is half open. Tighten the easy link set screw.



Fuel Tank

1 Install the inside parts of fuel tank as shown.

2 Assemble the outside fuel pipe as shown.

3 Tighten the Velcro ties secure the fuel tank.

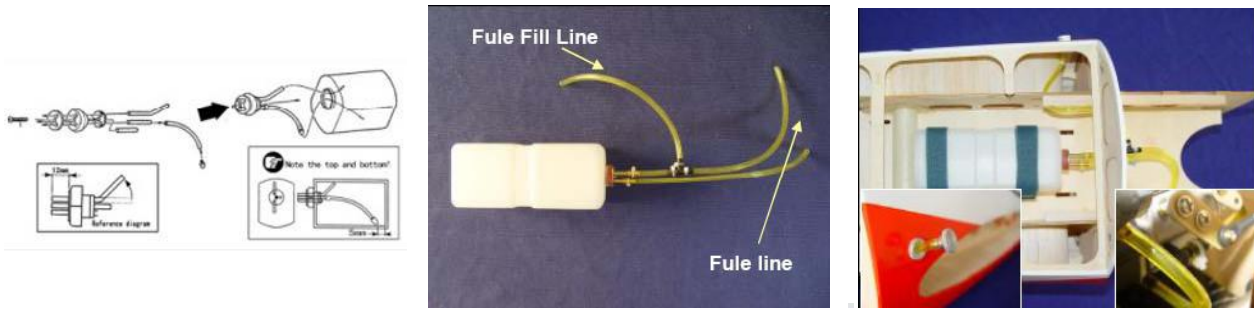

Aero-Tow

1 Install the aero-tow and servo onto the plywood 1 with screws.

2 Find the right position on the fuselage then cut a hole for the aero-tow. Install the plywood 1 as shown in the photos. Stick it into the fuselage very well.

3 Stick the plywood 2 and 3 next to the plywood 1. Make the hole same position as in the fuselage.

4 Insert the stick (pushrod) into the aero-tow and connect the other side onto the servo arm.

5 Install the rings and wires as shown.

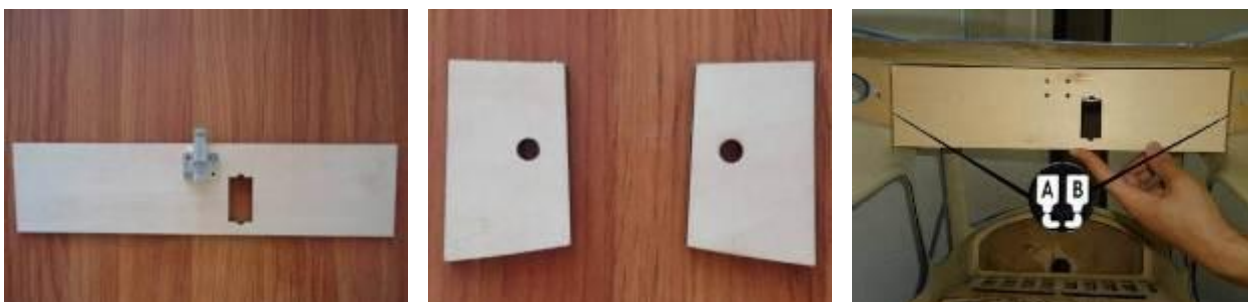

Plywoold 1

plywood 2 and 3



Stairs

Findout the stair parts and the screws.

Install the wood stair model onto the aluminume support by screws as shown. Lock the stair support onto the fuselage (you need to cut holes to install the stair onto the fuselage).

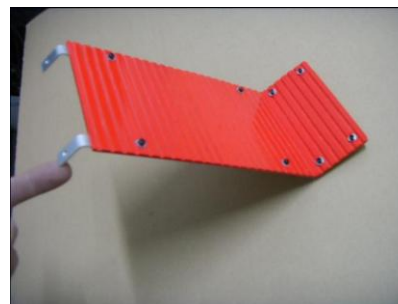

Chairs

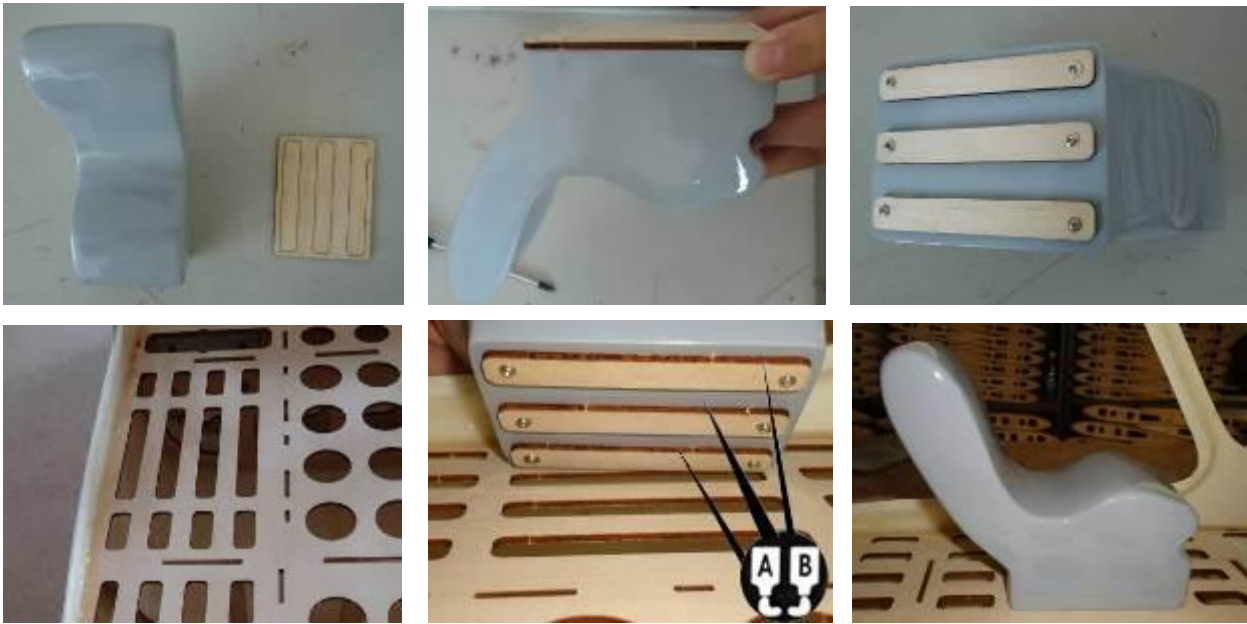

Doors Installation

Use screws and hinge install the doors onto the fuselage.

Use magnet on the doors and fuselage. Stick them to the right position.

Find and mark the right positions on the back side of the wings. Cut out the film and stick another pc of magnet on the back of the wings. So that the door could keep open when you need to refill the fuel tank or change the batteries.

Put the dashboard in the right position.





Wood Decoration

Stick the wood decoration into the fuselage place as shown.

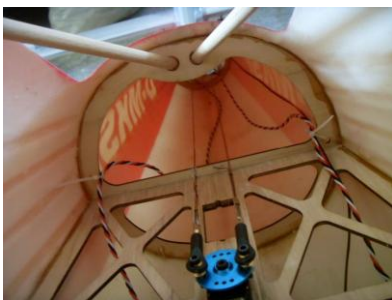
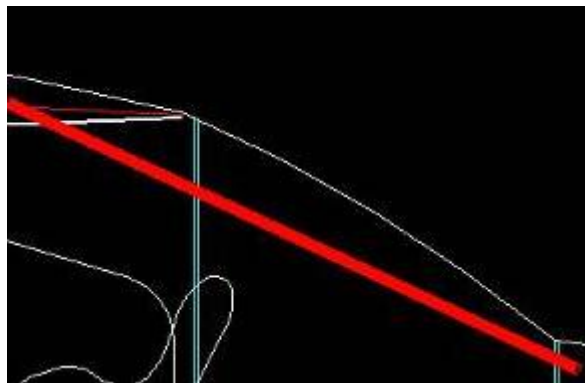
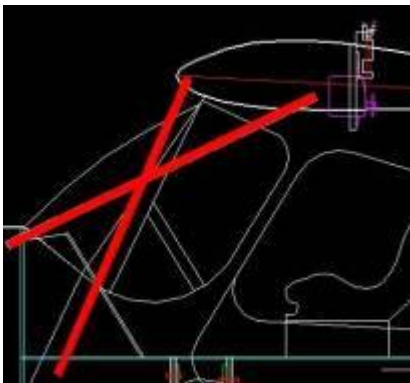

Spinner



Center of Gravity

The center of gravity is on the rear of the wings tube.

Your balance at the CG will determine the final mounting location for batteries. Mount batteries and secure with Nylon zip ties.

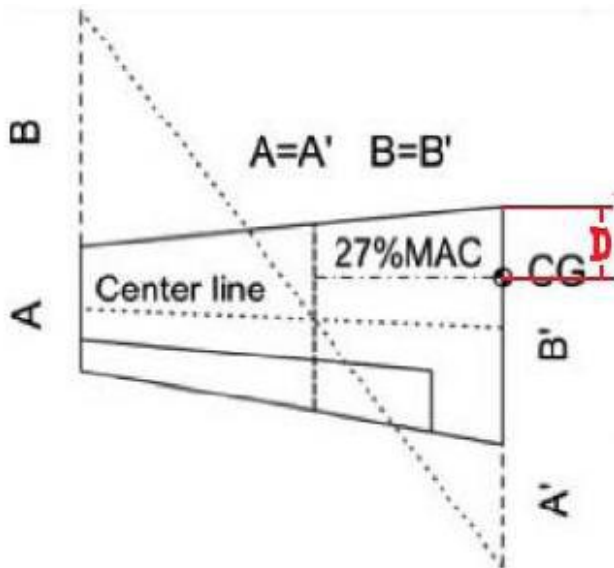
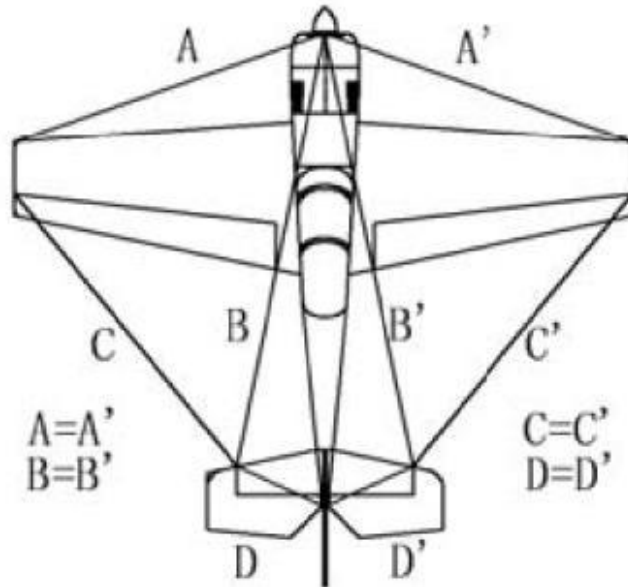

Measure the CG from the leading edge of wing root rib. Adjust the battery pack location. For CG proper position should be at 27% MAC. This recommendation balance point is for your first flights. The CG can be moved around later to fit your personal taste.

Wilga 100cc D = 136 mm

Wilga 50cc D = 116 mm

Wilga 30cc D = 100 mm

Wilga 20cc D = 90mm

Power on to trim your plane.

1. Range check the radio (test whether the Engine/Motor is running or not).
2. Ensure that the servos and control surfaces move smoothly and in the correct direction.
3. Adjust the servo throw. The chart below is the recommended throws for the first flight. You can adjust the servo arms and control horn length later to fit your flying style.

Control Throw:

| | Surface | Throws | Exp |
|---------------|----------|------------|-----|
| Common flying | Ailcron | 20 degrees | 25% |
| | Elevator | 20 degrees | 25% |
| | Rudder | 30 degrees | 30% |

| | | | |
|------------|----------|------------|-----|
| 3 D flying | Aileron | 40 degrees | 45% |
| | Elevator | 40 degrees | 45% |
| | Rudder | 45 degrees | 45% |

Trail run the Engine to check its stability at high speed and low speed to ensure there are no problems with vibration on the model. Run the motor at high speed about 30 min, check the Engine and make sure the temperature is below the prescription of manufacturer.